

WORLD-BEAM

Fotoelektrik Sensör Çözümleri



www.bannerengineering.com



BANNER[®]
more sensors, more solutions

Q12 Minyatür Seri

QS18 Kübik Seri

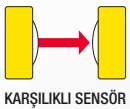

KARŞILIKLI SENSÖR

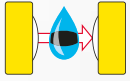

KARŞILIKLI SIVI ALGILAMA



REFLEKTÖRLÜ



POLARİZE REFLEKTÖRLÜ

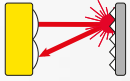

POLARİZE REFLEKTÖRLÜ LAZER SENSÖR

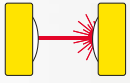

KARŞILIKLI LAZER SENSÖR

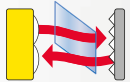

SAYDAM CİSİM ALGILAMA

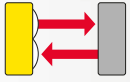

CİSİMDEN YANSIMALI

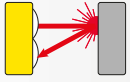

CİSİMDEN YANSIMALI LAZER SENSÖR

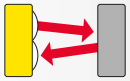

CİSİMDEN YASIMALI ODAKLAMALI SENSÖR

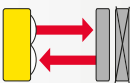

SABİT ALGILAMA MESAFELİ SENSÖR

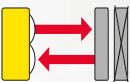

AYARLANABİLİR MESAFELİ SENSÖR

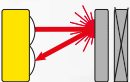

AYARLANABİLİR MESAFELİ LAZER SENSÖR

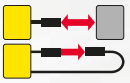

FİBER OPTİK SENSÖR

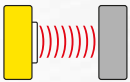

ULTRASONİK



Güçlendirilmiş gövde ve 360 derece görünür LED durum ışığı



M8 veya M12 konnektör bağlantılı sensörler



Özel PFA gövdeli sensörler



Ultra minyatür sensör



18 mm dişli ve dişsiz modeller



Kablolu ya da konnektörlü bağlantı şekilleri



360°



Lazer sensörler, Ultrasonik sensörler, AC/DC sensörler



AC/DC Besleme Gerilimli Sensörler



Uzun mesafeler için yüksek hassasiyet ile çalışabilen lazer sensörler

BEAM

QS30 Serisi Sensörler

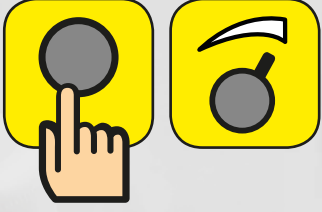

Potansiyometre veya butonla ayarlanabilme ayrıca kablo üzerinden öğretim seçeneği



Önden veya yandan montaj imkanı sağlayan kablolu ya da konnektörlü modeller
Her yönden görülebilen güçlü LED göstergeler

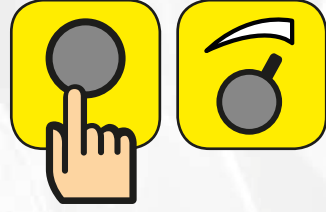

Potansiyometre veya butonla ayarlanabilen sensörler



Düz ya da yandan montaj imkanı sağlayan geniş ürün yelpazesi



Su veya diğer sıvılara karşı dayanıklı özel sensörler

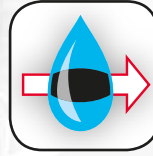

Q20 Kompakt Sensörler



360°

Her yönden görünen parlak LED gösterge

Endüstriyel ortamlar için tasarlanmış kompakt kübik gövde

Rahatlıkla ayarlanabilen tektur potansiyometreli modeller size kolay konfigürasyon yapma imkanı sağlar



Statik veya dinamik olarak ayarlanabilen, sinyal gücünü gösteren zaman ayarlı sensörler



Zor şartlar için güçlendirilmiş dış gövde



IP69K Sensörler



AC/DC Sensörler



Lazer Sensörler

Q12 Minyatür Sensörler

→ Görünür kırmızı LED ışık



Q12, 10-30 VDC, görünür kırmızı LED ışık

Algılama Modu	LO	DO	Algılama Mesafesi	Bağlantı	Çıkış
<p>KARŞILIKLI SENSÖR</p>	Q126E		2 m	2 m Kablo	Verici ünite
	Q126EQ			4-Pin M8 Kısa Kablo QD	Verici ünite
	Q126EQ3			3-Pin M8 Kısa Kablo QD	Verici ünite
	Q12AB6R	Q12RB6R		2 m Kablo	PNP/NPN
	Q12AB6RQ	Q12RB6RQ		4-Pin M8 Kısa Kablo QD	PNP/NPN
	Q12AP6RQ3	Q12RP6RQ3		3-Pin M8 Kısa Kablo QD	PNP
	Q12AN6RQ3	Q12RN6RQ3		3-Pin M8 Kısa Kablo QD	NPN
<p>REFLEKTÖRLÜ SENSÖR</p>	Q12AB6LV	Q12RB6LV	1,5 m (BRT-60X40C ile)	2 m Kablo	PNP/NPN
	Q12AB6LVQ	Q12RB6LVQ		4-Pin M8 Kısa Kablo QD	PNP/NPN
	Q12AP6LVQ3	Q12RP6LVQ3		3-Pin M8 Kısa Kablo QD	PNP
	Q12AN6LVQ3	Q12RN6LVQ3		3-Pin M8 Kısa Kablo QD	NPN
<p>POLARİZE REFLEKTÖRLÜ SENSÖR</p>	Q12AB6LP	Q12RB6LP	1 m (BRT-60X40C ile)	2 m Kablo	PNP/NPN
	Q12AB6LPQ	Q12RB6LPQ		4-Pin M8 Kısa Kablo QD	PNP/NPN
	Q12AP6LPQ3	Q12RP6LPQ3		3-Pin M8 Kısa Kablo QD	PNP
	Q12AN6LPQ3	Q12RN6LPQ3		3-Pin M8 Kısa Kablo QD	NPN
<p>SABİT ALGILAMA MESAFELİ SENSÖR</p>	Q12AB6FF15	Q12RB6FF15	15 mm	2 m Kablo	PNP/NPN
	Q12AB6FF15Q	Q12RB6FF15Q		4-Pin M8 Kısa Kablo QD	PNP/NPN
	Q12AP6FF15Q3	Q12RP6FF15Q3		3-Pin M8 Kısa Kablo QD	PNP
	Q12AN6FF15Q3	Q12RN6FF15Q3		3-Pin M8 Kısa Kablo QD	NPN
	Q12AB6FF30	Q12RB6FF30	30 mm	2 m Kablo	PNP/NPN
	Q12AB6FF30Q	Q12RB6FF30Q		4-Pin M8 Kısa Kablo QD	PNP/NPN
	Q12AP6FF30Q3	Q12RP6FF30Q3		3-Pin M8 Kısa Kablo QD	PNP
	Q12AN6FF30Q3	Q12RN6FF30Q3		3-Pin M8 Kısa Kablo QD	NPN
	Q12AB6FF50	Q12RB6FF50	50 mm	2 m Kablo	PNP/NPN
	Q12AB6FF50Q	Q12RB6FF50Q		4-Pin M8 Kısa Kablo QD	PNP/NPN
	Q12AP6FF50Q3	Q12RP6FF50Q3		3-Pin M8 Kısa Kablo QD	PNP
	Q12AN6FF50Q3	Q12RN6FF50Q3		3-Pin M8 Kısa Kablo QD	NPN

Kimyasallara dayanıklı sensörler için BANNER ile irtibata geçiniz.

Bağlantı Seçenekleri: PNP ve NPN Modeller için

-	2 m	2 m PVC kablolu (Ek yok).
W/30	9 m	9 m PVC kablolu modeller için 2 m kablolu modelin koduna W/30 ekleyiniz.
Q	M8	150 mm 4 pinli M8 soketli kısa kablolu modeller için kodun sonuna "Q" ekleyiniz.
Q5	M12	150 mm 4 pinli M12 soketli kısa kablolu modeller için kodun sonuna "Q5" ekleyiniz.

Bağlantı Seçenekleri: PNP ve NPN Modeller için



Q3	M8	150 mm 3 pinli M8 soketli kısa kablolu modeller için kodun sonuna "Q3" ekleyiniz. I/O blokları ile uyumlu.
Bağlantı Seçenekleri: PFA kimyasallara dayanıklı modeller		
-	2 m	PFA gövdeli sensörleri 2 m kablolu olarak tedarik etmek için kodun sonuna "CR" ekleyiniz.

Q20 Kompakt Sensörler

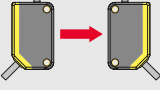
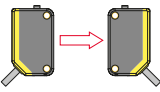
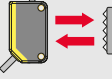

→ Görünür kırmızı LED ışık → Infrared LED ışık

Q20, 10-30 VDC, görünür kırmızı LED ışık ve infrared LED ışık

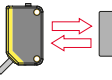
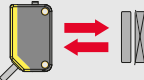
Algılama Modu	Model (PNP)		Algılama Mesafesi	Bağlantı
 KARŞILIKLI SENSÖR	Q20E	Verici ünite	12 m	2 m Kablo
	Q20EQ5	Verici ünite		4-Pin M12 Kısa Kablo QD
	Q20PR			2 m Kablo
	Q20PRQ5			4-Pin M12 Kısa Kablo QD
 KARŞILIKLI SENSÖR	Q20EL	Verici ünite	20 m	2 m Kablo
	Q20ELQ5	Verici ünite		4-Pin M12 Kısa Kablo QD
	Q20PRL			2 m Kablo
	Q20PRLQ5			4-Pin M12 Kısa Kablo QD
 REFLEKTÖRLÜ SENSÖR	Q20PLV		6 m (BRT-84 ile)	2 m Kablo
	Q20PLVQ5			4-Pin M12 Kısa Kablo QD
 POLARİZE REFLEKTÖRLÜ SENSÖR	Q20PLP		4 m (BRT-84 ile)	2 m Kablo
	Q20PLPQ5			4-Pin M12 Kısa Kablo QD
 CİSİMDEN YANSIMALI SENSÖR	Q20PD		250 mm	2 m Kablo
	Q20PDQ5			4-Pin M12 Kısa Kablo QD
	Q20PDL		800 mm	2 m Kablo
	Q20PDLQ5			4-Pin M12 Kısa Kablo QD
 CİSİMDEN YANSIMALI SENSÖR	Q20PDXL		1500 mm	2 m Kablo
	Q20PDXLQ5			4-Pin M12 Kısa Kablo QD
 SABİT ALGILAMA MESAFELİ SENSÖR	Q20PFF50		0-50 mm	2 m Kablo
	Q20PFF50Q5			4-Pin M12 Kısa Kablo QD
	Q20PFF100		0-100 mm	2 m Kablo
	Q20PFF100Q5			4-Pin M12 Kısa Kablo QD
	Q20PFF150		0-150 mm	2 m Kablo
	Q20PFF150Q5			4-Pin M12 Kısa Kablo QD

NPN modeller:

NPN modeller için ilgili koddaki "P" yerine "N" ekleyiniz.

Arıza ve alarm modu:

Arıza ve alarm çıkışı mevcuttur, daha fazla bilgi için BANNER ile irtibata geçiniz.

Bağlantı Seçenekleri		
-	2 m	2 m PVC kablolu (Ek yok).
W/30	9 m	9 m PVC kablolu modeller için 2 m kablolu modelin koduna W/30 ekleyiniz.
Q	M8	150 mm 4 pinli M8 soketli kısa kablolu modeller için kodun sonuna "Q" ekleyiniz.
Q5	M12	150 mm 4 pinli M12 soketli kısa kablolu modeller için kodun sonuna "Q5" ekleyiniz.

Bağlantı Seçenekleri		
Q7	M8	4-pinli M8 soketli kısa kablolu modeller için kodun sonuna "Q7" ekleyiniz.

QS18 Serisi Sensörler



→ Görünür Kırmızı LED ışık → Infrared LED ışık → * Görünür kırmızı lazer ışık

QS18, 10-30 VDC, görünür kırmızı LED ışık, infrared LED ışık ve görünür kırmızı lazer ışık

Algılama Modu	Model (PNP)		Algılama Mesafesi	Bağlantı
 KARŞILIKLI SENSÖR	QS186E	Verici ünite	20 m	2 m Kablo
	QS186EQ8	Verici ünite		4-pin M12 QD
	QS18VP6R			2 m Kablo
	QS18VP6RQ8			4-pin M12 QD
 KARŞILIKLI SENSÖR	QS186EB	Verici ünite	3 m	2 m Kablo
	QS186EBQ8	Verici ünite		4-pin M12 QD
	QS18VP6RB			2 m Kablo
	QS18VP6RBQ8			4-pin M12 QD
 REFLEKTÖRLÜ SENSÖR	QS18VP6LV		6,5 m (BRT-84 ile)	2 m Kablo
	QS18VP6LVQ8			4-pin M12 QD
 POLARİZE REFLEKTÖRLÜ SENSÖR	QS18VP6LP		3,5 m (BRT-84 ile)	2 m Kablo
	QS18VP6LPQ8			4-pin M12 QD
 SINIF 1 – LAZER POLARİZE REFLEKTÖRLÜ SENSÖR	QS18VP6LLP	Sınıf 1	0,1-10 m (BRT-51X51BM ile)	2 m Kablo
	QS18VP6LLPQ8			4-pin M12 QD
 SINIF 1 LAZER VERİCİ ÜNİTE	QS186LE	Sınıf 1 Lazer verici ünite	15 m (QS18 alıcı ünitesi ile kazanç değeri: 4500x)	2 m Kablo
	QS186LEQ8			4-pin M12 QD
 SINIF 2 LAZER VERİCİ ÜNİTE	QS186LE2	Sınıf 2 Lazer verici ünite	15 m (QS18 alıcı ünitesi ile kazanç değeri: 7000x)	2 m Kablo
	QS186LE2Q8			4-pin M12 QD
 CİSİMDEN YANSIMALI SENSÖR	QS18VP6D		450 mm	2 m Kablo
	QS18VP6DQ8			4-pin M12 QD
 CİSİMDEN YANSIMALI SENSÖR	QS18VP6DB	Cismd. Yansımali	450 mm	2 m Kablo
	QS18VP6DBQ8	Cismd. Yansımali		4-pin M12 QD
	QS18VP6W	Geniş açılı	100 mm	2 m Kablo
	QS18VP6WQ8	Geniş açılı		4-pin M12 QD
 CİSİMDEN YANSIMALI SINIF 1 LAZER	QS18VP6LD	Sınıf 1	300 mm	2 m Kablo
	QS18VP6LDQ8			4-pin M12 QD
 CİSİMDEN YANSIMALI ODAKLAMALI SENSÖR	QS18VP6CV15		16 mm	2 m Kablo
	QS18VP6CV15Q8			4-pin M12 QD
	QS18VP6CV45		43 mm	2 m Kablo
	QS18VP6CV45Q8			4-pin M12 QD

NPN modeller:

NPN modeller için ilgili koddaki "P" yerine "N" ekleyiniz (örnek QS18VN6R).

QS18 Serisi Sensörler



Görünür Kırmızı LED ışık



Görünür kırmızı lazer ışık

QS18, 10-30 VDC, görünür kırmızı LED ışık ve görünür kırmızı lazer ışık

Algılama Modu	Model (PNP)		Algılama Mesafesi	Bağlantı
<p>SABİT ALGILAMA MESAFELİ SENSÖR</p>	QS18VP6FF50		0-50 mm	2 m Kablo
	QS18VP6FF50Q8			4-pin M12 QD
	QS18VP6FF100		0-100 mm	2 m Kablo
	QS18VP6FF100Q8			4-pin M12 QD
Algılama Modu	Model (PNP)	Model (Bipolar)	Algılama Mesafesi	Bağlantı
<p>AYARLANABİLİR MESAFELİ ÖN FON BASTIRMALI SENSÖR</p>	QS18VP6AFF200	QS18AB6AFF200	30-200 mm arası ayarlanabilir	2 m Kablo
	QS18VP6AFF200Q5	QS18AB6AFF200Q5		4-pin M12 Kısa Kablo QD
	QS18VP6AFF40	QS18AB6AFF40	15-40 mm arası ayarlanabilir	2 m Kablo
	QS18VP6AFF40Q5	QS18AB6AFF40Q5		4-pin M12 Kısa Kablo QD
<p>AYARLANABİLİR MESAFELİ-ARKA FON BASTIRMALI SENSÖR</p>	QS18VP6AF300	QS18AB6AF300	30-300 mm arası ayarlanabilir	2 m Kablo
	QS18VP6AF300Q5	QS18AB6AF300Q5		4-pin M12 Kısa Kablo QD
	QS18VP6AF40	QS18AB6AF40	15-40 mm arası ayarlanabilir	2 m Kablo
	QS18VP6AF40Q5	QS18AB6AF40Q5		4-pin M12 Kısa Kablo QD
	QS18VP6AF100		1 mm ayarlama hassasiyeti 20-100 mm arası ayarlanabilir	2 m Kablo
	QS18VP6AF100Q5			4-pin M12 Kısa Kablo QD
Algılama Modu	Model (PNP)		Algılama Mesafesi	Bağlantı
<p>AYARLANABİLİR MESAFELİ ARKAFON BASTIRMALI LAZER SENSÖR</p>	QS18VP6LAF	Sınıf 1	1 mm ayarlama hassasiyeti 30-150 mm arası ayarlanabilir	2 m Kablo
	QS18VP6LAFQ5			4-pin M12 Kısa Kablo QD
<p>AYARLANABİLİR MESAFELİ ARKAFON BASTIRMALI LAZER SENSÖR</p>	QS18VP6LAF250	Sınıf 2	20 mm ayarlama hassasiyeti 50-250 mm arası ayarlanabilir	2 m Kablo
	QS18VP6LAF250Q5			4-pin M12 Kısa Kablo QD
<p>CAM FİBER SENSÖR</p>	QS18VP6F		Algılama mesafesi kullanılan fibere göre değişmektedir	2 m Kablo
	QS18VP6FQ8			4-pin M12 QD
<p>PLASTİK FİBER SENSÖR</p>	QS18VP6FP		Algılama mesafesi kullanılan fibere göre değişmektedir	2 m Kablo
	QS18VP6FPQ8			4-pin M12 QD

NPN modeller:

NPN modeller için ilgili koddaki "P" yerine "N" ekleyiniz (örnek, QS18VN6FF50).

Bipolar PNP/NPN çıkışlı modeller:



PNP/NPN çıkışlı model seçenekleri için BANNER ile irtibata geçiniz.

QS18 Laser Pointers

 Görünür kırmızı lazer ışık

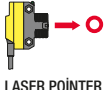
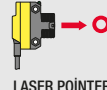
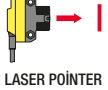
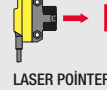
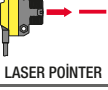
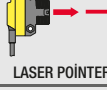

QS18, 10-30 VDC, görünür kırmızı lazer ışık

Algılama Modu	Model	Bağlantı	Algılama Modu	Model	Bağlantı
 LASER POINTER	QS186LE10	2 m Kablo	 LASER POINTER	QS186LE210	2 m Kablo
	QS186LE10Q8	4-pin M12 QD		QS186LE210Q8	4-pin M12 QD
 LASER POINTER	QS186LE11	2 m Kablo	 LASER POINTER	QS186LE211	2 m Kablo
	QS186LE11Q8	4-pin M12 QD		QS186LE211Q8	4-pin M12 QD
 LASER POINTER	QS186LE12	2 m Kablo	 LASER POINTER	QS186LE212	2 m Kablo
	QS186LE12Q8	4-pin M12 QD		QS186LE212Q8	4-pin M12 QD
 LASER POINTER	QS186LE14	2 m Kablo	 LASER POINTER	QS186LE214	2 m Kablo
	QS186LE14Q8	4-pin M12 QD		QS186LE214Q8	4-pin M12 QD





Sınıf 1



Sınıf 2

QS18 Expert Sensörler

 Görünür Kırmızı LED ışık
 Infrared LED ışık

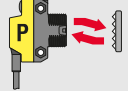
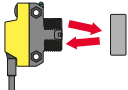
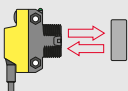
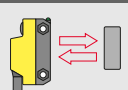
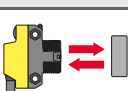
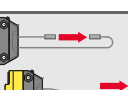

QS18 Expert, 10-30 VDC, görünür kırmızı LED ışık ve infrared LED ışık

Algılama Modu	Model (PNP)	Algılama Mesafesi	Bağlantı
 POLARİZE REFLEKTÖRLÜ SENSÖR	QS18EP6LP	3,5 m (BRT-84 ile)	2 m Kablo
	QS18EP6LPQ8		4-pin M12 QD
 CİSİMDEN YANSIMALI ODAKLAMALI SENSÖR	QS18EP6CV15	16 mm	2 m Kablo
	QS18EP6CV15Q8		4-pin M12 QD
	QS18EP6CV45	43 mm	2 m Kablo
	QS18EP6CV45Q8		4-pin M12 QD
 CİSİMDEN YANSIMALI SENSÖR	QS18EP6D	800 mm	2 m Kablo
	QS18EP6DQ8		4-pin M12 QD
 CİSİMDEN YANSIMALI SENSÖR	QS18EP6DB	500 mm	2 m Kablo
	QS18EP6DBQ8		4-pin M12 QD
 GENİŞ AÇILI CİSİMDEN YANSIMALI SENSÖR	QS18EP6W	300 mm	2 m Kablo
	QS18EP6WQ8		4-pin M12 QD
 CİSİMDEN YANSIMALI SENSÖR	QS18EP6DV	600 mm	2 m Kablo
	QS18EP6DVQ8		4-pin M12 QD
 PLASTİK FİBER SENSÖR	QS18EP6FP	Algılama mesafesi kullanılan fibere göre değişmektedir	2 m Kablo
	QS18EP6FPQ8		4-pin M12 QD

NPN Modeller:

NPN modelleri için ilgili koddaki "P" yerine "N" ekleyiniz (örnek, QS18EN6LP).

QS18 Ultrasonik Sensörler

QS18 Ultrasonik, 12-30 VDC

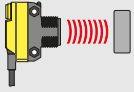
Algılama Modu	Model (PNP)	Algılama Mesafesi	Öğretme Seçenekleri	Gövde	Bağlantı
 ULTRASONİK	QS18UPA	50-500 mm	Butonla veya Uzaktan öğretim	IP67	2 m Kablo
	QS18UPAQ8				4-pin M12 QD
	QS18UPAE		Uzaktan öğretim	Sızdırmaz-Epoksi IP68	2 m Kablo
	QS18UPAEQ8				4-pin M12 QD

QS18 Ultrasonik Dalga Yönlendirici

Model	Boyut	Açıklama
 UWG18-5.0 UWG18-6.4	Ø 5 mm iç yarıçap Ø 6,4 mm iç yarıçap	Dalga yönlendirici metrik 18 dişle monte edilerek, ultrasonik dalganın yayılmadan odaklanmasını sağlar.



Bağlantı Seçenekleri

-	2 m	2 m PVC kablolu (Ek yok).
W/30	9 m	9 m PVC kablolu modeller için 2 m kablolu modelin koduna W/30 ekleyiniz.
Q	M8	150 mm 4 pinli M8 soketli kısa kablolu modeller için kodun sonuna "Q" ekleyiniz.
Q5	M12	150 mm 4 pinli M12 soketli kısa kablolu modeller için kodun sonuna "Q5" ekleyiniz.

Q7	M8	4-pinli M8 soketli kısa kablolu modeller için kodun sonuna "Q7" ekleyiniz.
Q8	M12	4-pinli M12 soketli kısa kablolu modeller için kodun sonuna "Q8" ekleyiniz.

Bağlantı Seçenekleri: (AF Modeller hariç)

Q	M8	150 mm 4 pinli M8 soketli kısa kablolu modeller için kodun sonuna "Q" ekleyiniz.
Q5	M12	150 mm 4 pinli M12 soketli kısa kablolu modeller için kodun sonuna "Q5" ekleyiniz.

-  Görünür Kırmızı LED ışık
 Infrared LED ışık

QS18 AC/DC Besleme

QS18, 20-140 VAC/DC or 20-270 VAC/DC, görünür kırmızı LED ışık ve infrared LED ışık

Algılama Modu	LO	DO	Algılama Mesafesi	Bağlantı	MOSFET Çıkış
 KARŞILIKLI SENSÖR	QS18WE		20 m	2 m Kablo	Verici ünite
	QS18APWR	QS18RPWR			P-MOSFET
	QS18ANWR	QS18RNWR			N-MOSFET
 REFLEKTÖRLÜ SENSÖR	QS18APWLV	QS18RPWLV	6,5 m (BRT-84 ile)	2 m Kablo	P-MOSFET
	QS18ANWLV	QS18RNWLV			N-MOSFET
 POLARİZE REFLEKTÖRLÜ SENSÖR	QS18APWLP	QS18RPWLP	3,5 m (BRT-84 ile)	2 m Kablo	P-MOSFET
	QS18ANWLP	QS18RNWLP			N-MOSFET
 CİSİMDEN YANSIMALI SENSÖR	QS18APWDL	QS18RPWDL	450 mm	2 m Kablo	P-MOSFET
	QS18ANWDL	QS18RNWDL			N-MOSFET
 CİSİMDEN YANSIMALI SENSÖR	QS18APWDXL	QS18RPWDXL	1 m	2 m Kablo	P-MOSFET
	QS18ANWDXL	QS18RNWDXL			N-MOSFET

QD modeller:

4-pin 150 mm Micro-style için kısa kablolu QD, model numarasına Q2 ekleyiniz (örnek; QS18WEQ2).

QS30 Gelişmiş Sensörler



→ Görünür Kırmızı Işık

→ Infrared LED ışık

QS30, 10-30 VDC, görünür kırmızı LED ışık ve infrared LED ışık

Algılama Modu	Model	Algılama Mesafesi	Bağlantı	Çıkış	
 KARŞILIKLI SENSÖR	QS30E	60 m	2 m Kablo	Verici ünite	
	QS30EQ		5-pin M12 QD		
	QS30R		2 m Kablo	Bipolar PNP/NPN	
	QS30RQ		5-pin M12 QD		
 YÜKSEK GÜÇLÜ KARŞILIKLI SENSÖR	QS30EX	213 m	2 m Kablo	Verici ünite	
	QS30EXQ		5-pin M12 QD		
	QS30ARX		2 m Kablo	Bipolar PNP/NPN	LO
	QS30ARXQ		5-pin M12 QD		
	QS30RRX		2 m Kablo	Bipolar PNP/NPN	DO
	QS30RRXQ		5-pin M12 QD		
 KARŞILIKLI SU ALGILAMA SENSÖRÜ	QS30EXH2O	(Verici ünite)	2 m Kablo	Verici ünite	
	QS30EXH2OQ5		5-pin M12 Kısa Kablo QD		
	QS30ARH2O	2 m	2 m Kablo	Bipolar PNP/NPN	LO
	QS30ARH2OQ5		5-pin M12 Kısa Kablo QD		
	QS30RRH2O		2 m Kablo	Bipolar PNP/NPN	DO
	QS30RRH2OQ5		5-pin M12 Kısa Kablo QD		
	QS30ARXH2O	4 m Yüksek-Güç	2 m Kablo	Bipolar PNP/NPN	LO
	QS30ARXH2OQ5		5-pin M12 Kısa Kablo QD		
	QS30RRXH2O		2 m Kablo	Bipolar PNP/NPN	DO
	QS30RRXH2OQ5		5-pin M12 Kısa Kablo QD		
 ÇOK YÜKSEK GÜÇLÜ KARŞILIKLI SU ALGILAMA SENSÖRÜ	QS30EXSH2O	8 m Süper yüksek-güç	2 m Kablo	Verici ünite	
	QS30EXSH2OQ5		5-pin M12 Kısa Kablo QD		
	QS30ARXSH2O		2 m Kablo	Bipolar PNP/NPN	LO
	QS30ARXSH2OQ5		5-pin M12 Kısa Kablo QD		
	QS30RRXSH2O		2 m Kablo	Bipolar PNP/NPN	DO
	QS30RRXSH2OQ5		5-pin M12 Kısa Kablo QD		
 REFLEKTÖRLÜ SENSÖR	QS30LV	12 m (BRT-84 ile)	2 m Kablo	Bipolar PNP/NPN	
	QS30LVQ		5-pin M12 QD		
 POLARİZE REFLEKTÖRLÜ SENSÖR	QS30LP	8 m (BRT-84 ile)	2 m Kablo	Bipolar PNP/NPN	
	QS30LPQ		5-pin M12 QD		
 CİSİMDEN YANSIMALI SENSÖR	QS30D	1 m	2 m Kablo	Bipolar PNP/NPN	
	QS30DQ		5-pin M12 QD		
 AYARLANABİLİR MESAFELİ ARKAFON BASTIRMALI SENSÖR	QS30AF600	50-600 mm arasında ayarlanabilir	2 m Kablo	Bipolar PNP/NPN	
	QS30AF600Q		5-pin M12 QD		
 AYARLANABİLİR MESAFELİ ÖN FON BASTIRMALI SENSÖR	QS30AFF400	50-400 mm arasında ayarlanabilir	2 m Kablo	Bipolar PNP/NPN	
	QS30AFF400Q		5-pin M12 QD		

Tüm QS30 modellerde: 9m PVC kablolu model için, 2m model numarasına W/30 ekleyiniz (örnek: QS30E W/30).

QS30 Gelişmiş Sensörler

→ Görünür kırmızı LED ışık

QS30, 10-30 VDC, görünür kırmızı LED ışık

Algılama Modu	Model	Algılama Mesafesi	Bağlantı	Çıkış
 <p>SABİT ALGILAMA MESAFELİ SENSÖR</p>	QS30FF200	200 mm	2 m Kablo	Bipolar PNP/NPN
	QS30FF200Q		5-pin M12 QD	
	QS30FF400	400 mm	2 m Kablo	
	QS30FF400Q		5-pin M12 QD	
	QS30FF600	600 mm	2 m Kablo	
	QS30FF600Q		5-pin M12 QD	







→ Görünür Kırmızı LED ışık

→ Görünür kırmızı lazer ışık

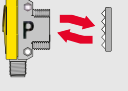
QS30 Expert

QS30 Expert, 10-30 VDC, görünür kırmızı Led ışık ve görünür kırmızı lazer ışık

Algılama Modu	Model	Algılama Mesafesi	Bağlantı
 <p>POLARİZE REFLEKTÖRLÜ LAZER SENSÖR</p>	QS30LLP	0,2-18 m (BRT-36X40BM ile)	2 m Kablo
	QS30LLPQ		5-pin M12 QD
	QS30LLPC		2 m Kablo
	QS30LLPCQ		5-pin M12 QD
 <p>ŞEFFAF CİSİM ALGILAMA REFLEKTÖRLÜ SENSÖR</p>	QS30ELVC	100 mm to 2 m	2 m Kablo
	QS30ELVCQ		5-pin M12 QD
 <p>CİSİMDEN YANSIMALI SENSÖR</p>	QS30EDV	Yüksek Hız: 1100 mm Normal: 1400 mm	2 m Kablo
	QS30EDVQ		5-pin M12 QD
 <p>CİSİMDEN YANSIMALI LAZER SENSÖR</p>	QS30LD	400 mm	2 m Kablo
	QS30LDQ		5-pin M12 QD
	QS30LDL	800 mm	2 m Kablo
	QS30LDLQ		5-pin M12 QD

Lazer polarize reflektörlü sensörler beraberinde BRT-TVHG-2X2 reflektör içerir.

Şeffaf cisim algılama sensörü beraberinde BRT-2X2LVC ve BRT40X19A reflektörleride içerir.



→ Görünür Kırmızı LED ışık

→ Infrared LED ışık

































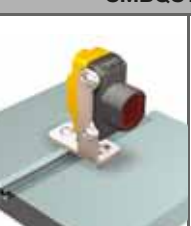





QS30 AC/DC Besleme

QS30, 12-250 VDC or 24-250 VAC, görünür kırmızı Led ışık ve infrared LED ışık

Algılama Modu	Model	Algılama Mesafesi	Bağlantı	Çıkış
 <p>KARŞILIKLI SENSÖR</p>	QS303E	60 m	2 m Kablo	Verici Ünite
	QS30VR3R		2 m Kablo	SPDT Elektromekanik Röle
 <p>POLARİZE REFLEKTÖRLÜ SENSÖR</p>	QS30VR3LP	8 m (BRT-84 ile)	2 m Kablo	SPDT Elektromekanik Röle
 <p>SABİT ALGILAMA MESAFELİ SENSÖR</p>	QS30VR3FF200	200 mm	2 m Kablo	SPDT Elektromekanik Röle
	QS30VR3FF400	400 mm	2 m Kablo	
	QS30VR3FF600	600 mm	2 m Kablo	

QS18 & Q12 Montaj Braketleri (Aparatları)





















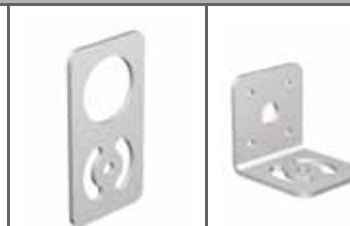





QS18 Braketleri

SMB18A		SMB18AFA		SMBAMS18P		SMBAMS18RA	
							
SMB18ATFA		SMB18FAM10		SMBQS18A		SMBQS18AF	
			 M10				
SMB18FM		SMB18Q		SMBQS18DIN		SMBQS18RA	
							
SMB18SF		SMB18UR		SMBQS18Y		SMBQS18YL	
							
SMB312S		SMB4050YL		SMH241F			
							

Q12 Braketleri

SMBQ12A		SMBQ12T	
			

QS30 & Q20 Montaj Braketleri (Aparatları)

QS30 Braketleri					
SMB30A		SMB30FA		SMB30RAVK	
					
SMB30MM		SMB30Q		SMBAMS30P, SMBAMSBRA ile birlikte gösterilmiştir	
					
SMB30SC		SMBAMS30P		SMBAMS30RA, SMBAMSBRA ile birlikte gösterilmiştir	
					
SMBAMS30RA		SMBQS30L			
					
SMBQS30Y		SMBQS30YL			
					

Q20 Braketleri							
SMBQ20H		SMBQ20L		SMBQ20LV		SMBQ20U	
							

Endüstriyel Uygulamalar

İlaç Endüstrisi



İlaç Şişelerinde Kapak Algılama

Q12 Sensör, sabit mesafeli ışığı ile altından geçen plastik şişelerden kapağı olmayanları tespit ediyor.



Şırınga Sayma

QS18 Arka fon bastırmalı sensör, konveyörün ardındaki hareketleri dikkate almadan yalnızca şırıngaları tespit ederek sayıcıya iletiyor.

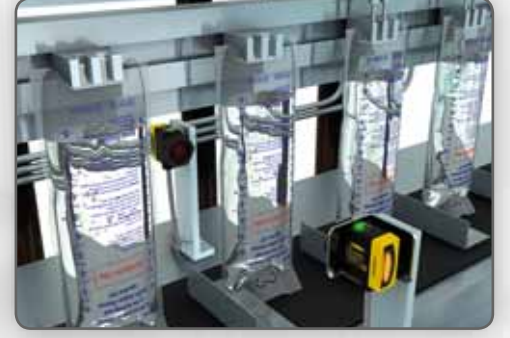

Şeffaf Şişe İçinde Sıvı Algılama

QS30 Su algılama sensörü, sıvılar tarafından emilen özel ışık dalga boyu sayesinde saydam cisimlerin içerisindeki sıvı seviyesini kontrol ediyor.

Gıda Endüstrisi



Şişe Kapak Algılama

Q12 Sensör, sabit mesafeli ışığı ile altından geçen plastik şişelerden kapağı olmayanları kapak renginden etkilenmeksizin tespit ediyor. Küçük gövdesi sayesinde dar alanlara kolaylıkla monte edilebiliyor.



Renkli Şişe Algılama

QS18U Ultrasonik sensör, hızlı akan konveyörden farklı renk ve parlaklıkta etiketlerle geçen şişeleri renk, saydamlık ve parlaklık farkı gözetmeksizin algılıyor.



Meyve Suyu Kartonu Algılama

QS30 Sensör, sabit mesafeli ışığı ile önünden geçen karton kutuların yüzeyini algılıyor, renk değişimlerinden etkilenmiyor.

Paketleme Endüstrisi



Tüp Dolumu

QS18 Lazer sensör uzaktan malzeme besleme ünitesini kontrol ederek, dolum öncesi tüplerin tamamının var olup olmadığını denetliyor.

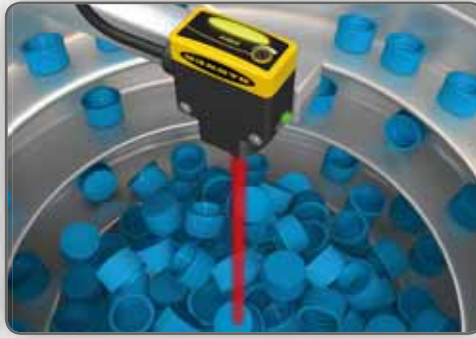

Besleyici Parçanın Algılanması

QS30 Uzun menzilli, arka fon bastırmalı sensör; dizici içerisindeki malzeme seviyesini kontrol ediyor. Malzeme miktarı öğretilen değer altına indiğinde yeni malzeme eklenmesi için operatörü uyarıyor.



Şeffaf Şişe Sayımı

QS30 Saydam cisim algılama sensörü, polarize reflektörden yansıyan ışının değişimini izleyerek hızlı ve güvenilir bir şekilde saydam cisimleri algılıyor



Konveyör ve Taşıma Endüstrisi



Tamamlanmamış Kutu Algılama

Q20 Polarize reflektörlü sensör yalnızca kendi reflektöründen yansıyan ışını algılıyor bunun dışında herhangi bir parlak yüzeyden yansıyan ışınları dikkate almıyor. Böylece parlak tenake yüzeylerde dahi sorunsuz çalışıyor.



Yükleme İstasyonundaki Paletin Algılanması

Q20 cisimden yansımali sensör, robot yüklemeye başlamadan önce paletin tam olarak yerinde olup olmadığını kontrol ediyor ve robota paletin yerinde olduğu bilgisini iletiyor.



220V AC Sensörle Parça Algılama

QS18 220V AC Sensor, uzun ve dağınık konveyör hatlarında özel güç kaynağı gerektirmeksizin, şehir şebekesi ile çalışabiliyor.

Otomotiv Endüstrisi



Sıvı Seviyesi Algılama

QS18U Ultrasonik sensör, sıvı seviyesini algılayarak, sıvı istenilen seviyenin altına düştüğünde veya üst seviyeye ulaştığında çıkış veriyor.



Araç Yıkama Prosesinde Araç Pozisyonu Algılama

Yoğun su buharı, toz ve büyük sıcaklık farklarının olduğu araç yıkama prosesinde dahi sorunsuz çalışan "QS30 High Power" serisi

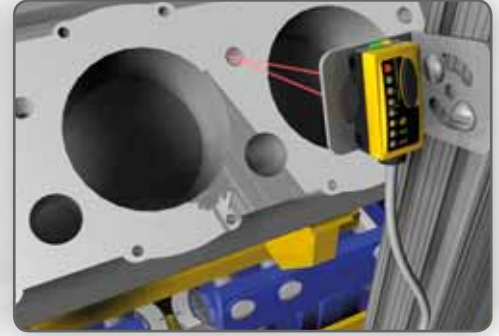

Vida Deliği Algılama

QS30 Cisimden yansımali lazer sensör 800mm ye kadar mesafeden çok küçük bir noktayı kontrol edebiliyor, bu uygulamada motor bloğu üzerindeki bağlantı deliğinin dış olup olmadığını kontrol ediyor.

Parça İşleme Endüstrisi

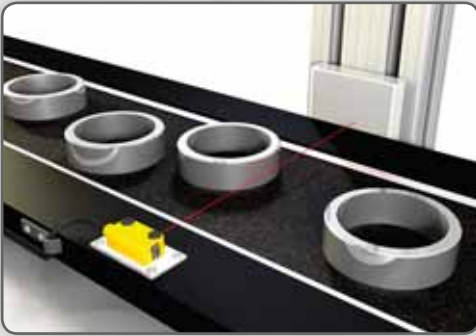

Parlak Nesne Sayma

Q12 küçük boyutları ve yüksek performansı ile birçok uygulamaya çözüm sunuyor, bu uygulamada reflektörden yansıyan ışınların kesilmesi ile parça varlığını sayıcıya iletiyor.

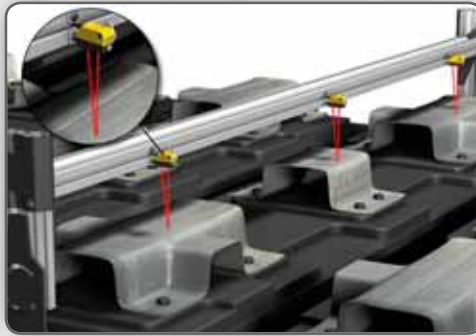

Parça Var-Yok Kontrolü

QS18 Arka fon bastırılmalı sensör, öğretildiği noktanın arkasındaki malzemeyi dikkate almaksızın, montaj öncesi kontrol edilmek istenilen parçanın yerinde olup olmadığını denetliyor.

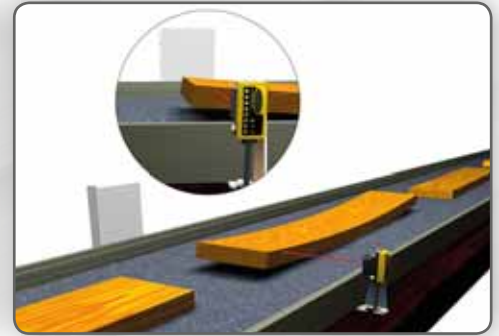

Düzlemsellik Kontrolü

QS30 Lazer sensör ağaç plakalardaki en küçük yükseklik değişimini algılayarak uyarı veriyor.



Sensörler

- Ürün Algılama
- Renk Algılama
- Seviye ve Mesafe Ölçümü
- Konumlandırma
- Kontrast ve Renk Algılama



Endüstriyel Kameralar

- Bilgisayar ve programlama gerektirmeyen endüstriyel kamera çözümleri
- Şekil Tanıma
- Barkod Okuma ve Ürün Takibi
- OCR/OCV
- Kompleks Parça Denetimi
- Parça Oryantasyonu
- Montaj Denetimi

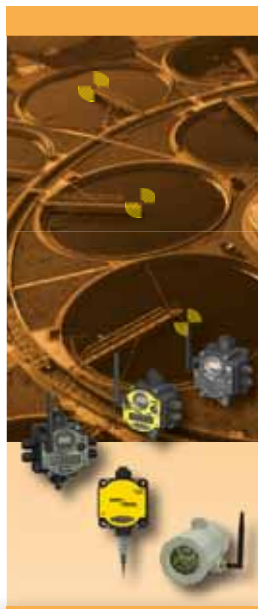

Kablosuz I/O

- Slip Ring Gerektiren Uygulamalar
- Tank Sahası Kontrolü
- Tarımsal Otomasyon Uygulamaları
- Proses otomasyonunda kablosuz haberleşme
- HVAC Uzaktan Kontrol
- Traffic Görüntüleme & Kontrol
- ATEX Onaylı Çözümler



İndikatör Işıklar

- Kutu & Parça Seçimi
- Hata/Yanlış Gösterimi
- Pick-to-Light Operatör Yönlendirme
- Parça Çağırma
- Yanlış Parça Seçim Sinyali
- Çalışma, Montaj Alanı ve Kabin İçi Aydınlatması



Makine Emniyeti

- Emniyet Işık Bariyerleri
- Optik Temassız Emniyet Sistemleri
- Ergonomik Çift-El Kontrol Cihazları
- Kapı Emniyet Kilitleri
- Acil Stop Ekipmanları
- Emniyet Röleleri
- Lazer Alan Tarayıcılar

Banner Çözümleri



Headquarters USA

Banner Engineering
9714 10th Avenue North
Minneapolis, Minnesota 55441
USA
☎ +1 763 544 3164
Fax: +1 763 544 3213
sensors@bannerengineering.com
www.bannerengineering.com



China

Banner Engineering Shanghai Rep Office
Rm. G/H/I, 28th Fl.,
Cross Region Plaza
No. 899, Lingling Road,
Shanghai 200030
☎ +86 21 54894500
sensors@bannerengineering.com.cn
www.bannerengineering.com.cn



Japan

Banner Engineering Japan
Cent-Urban Building 305
3-23-15 Nishi-Nakajima
Yodogawa-Ku, Osaka 532-0011
☎ +81 6 6309 0411
mail@bannerengineering.co.jp
www.bannerengineering.co.jp



Taiwan

Banner Engineering Int'l Incorporated
Taiwan Rep. Office
8F-2, No. 308, Sec. 1, Neihu Rd.
Taipei 114
☎ +886 2 8751 9966 #15
info@bannerengineering.com.tw
www.bannerengineering.com.tw



Europe, Middle East, Africa

Banner Engineering EMEA
Park Lane, Culliganlaan 2F
1831 Diegem | Belgium
☎ +32 (2) 456 07 80
Fax +32 (2) 456 07 89
mail@bannerengineering.com
www.bannerengineering.com/eu



India

Banner Engineering India – Pune (HQ)
Office No. 1001, 10th Floor
Sai Capital, Opp. ICC
Senapati Bapat Road
Pune 411016
☎ +91 20 66405624
salesindia@bannerengineering.com
www.bannerengineering.co.in



Mexico

Banner Engineering de Mexico
Edificio VAO
Av. David Alfaro Siqueiros No.103
Col. Valle Oriente C.P.66269
San Pedro Garza Garcia, Nuevo Leon
☎ 52-81-8363-2714
mexico@bannerengineering.com
www.bannerengineering.com.mx



Turkey

Banner Engineering Elk. San. Ve Tic. Ltd. Sti.
Barbaros Mah. Uphill Court Towers A
Blk D:49 34746 Atasehir Istanbul
☎ +90 216 688 8282
Fax: (+90) 216 688 8181
turkey@bannerengineering.com.tr
www.bannerengineering.com.tr



Banner 'dan tüm ihtiyaçlarınıza yönelik sensör çözümleri

www.bannerengineering.com

BANNER